

Amp-Trap 2000[®] Fuses

For Type 2, No Damage circuit protection in all the configurations you need.



Your problem:

You need maximum overcurrent protection to prevent costly damage to today's highly sensitive motor and electrical-system components. That way, plant shutdowns, replacement costs, and repair bills are kept to an absolute minimum.

Our solution: By opening in less than 1/4 cycle under short circuit conditions, Amp-Trap 2000 fuses current limit enough to prevent undue downstream damage — and therefore comply with the extra-stringent IEC, Type-2 standard. In addition to being the industries most current-limiting fuses, the time-delay feature allows for motor starting and transformer inrush current without nuisance opening adding to the reliability and longevity of your electrical system.

Want more information fast? For more technical or application-specific information, please call our Amp-Trap 2000 experts, at 978-462-6662; 416-252-9371 in Canada; or visit our website at ep.mersen.com.

A Amp-Trap 2000 Fuses

- Class J / AJT A2
- AJT Reducer Fuses..... A4
- Class L / A4BQ A6
- Class RK1 / A2D-R & A6D-R..... A8
- Class CC / ATDR..... A10
- Class CC / ATQR..... A12

AJT Time-delay/Class J

SmartSpot® with maximum circuit protection

Amp-Trap 2000® SmartSpot AJT fuses now provide a visual open fuse indicator. With advanced material technology the AJT fuse provides IEC Type 2 No Damage protection to main, feeder, and branch circuits, for all types of loads — yet, they require only half the mounting space needed for 600VAC Class RK fuses. AJT's time-delay characteristics are ideal for handling typical motor and transformer inrush currents, while also providing superior current-limiting ability.

Features/Benefits:

- Solid state SmartSpot visual blown fuse indicator
- Time-delay for motor starting and transformer inrush
- 300kA interrupting rating - self-certified, UL witnessed tests
- Extremely current-limiting for low peak let-thru current
- Most current-limiting UL class fuse
- Recommended for Arc Flash energy reduction
- Small footprint requires less mounting space and allows smaller, more economical fuse blocks
- Easy 2-to-1 selectivity for prevention of nuisance shutdowns
- Unique Class J dimensions prevent replacement errors
- High-visibility orange label gives instant brand recognition
- Metal-embossed date and catalog number for traceability and lasting identification
- Fiberglass body provides dimensional stability in harsh industrial settings
- High-grade silica filler ensures fast arc quenching
- Optional EI indicator/switch mount for AJT70 to 600 open fuse indication

Highlights:

- SmartSpot indicator
- Time-delay
- Highly current-limiting
- Arc Flash mitigating
- DC ratings
- Optional mechanical indicator (70 to 600A fuses)

Applications:

- Motor circuits
- Mains
- Feeders
- Branch circuits
- Lighting, heating & general loads
- Transformers
- Control panels
- Circuit breaker back-up
- Bus duct
- Load centers

Note: See motor fuse applications tables on page P7



Ratings:

Volts : 600VAC or less
: 500VDC or less

Amps : 1 to 600A

IR : 200kA I.R. AC
: 100kA I.R. DC

(Self-certified for 600VAC, 300kA I.R., UL witnessed).

Approvals:

AJT (1-600):

- UL listed to standard 248-8 File E2137
- DC listed to UL standard 248
- CSA certified to standard C22.2 No. 248.8
- IEC 269-2-1

AJT (70-600) EI:

- UL listed
- DC tested to UL standard 248



AJT Time-delay/Class J

Catalog Numbers (amps)

AJT1	AJT4-1/2	AJT25	AJT125
AJT1-1/4	AJT5	AJT30	AJT150
AJT1-1/2	AJT5-6/10	AJT35	AJT175
AJT1-6/10	AJT6	AJT40	AJT200
AJT1-8/10	AJT6-1/4	AJT45	AJT225
AJT2	AJT7	AJT50	AJT250
AJT2-1/4	AJT8	AJT60	AJT300
AJT2-1/2	AJT9	AJT70	AJT350
AJT2-8/10	AJT10	AJT80	AJT400
AJT3	AJT12	AJT90	AJT450
AJT3-2/10	AJT15	AJT100	AJT500
AJT3-1/2	AJT17-1/2	AJT110	AJT600
AJT4	AJT20		

Note: SmartSpot visual indicator is not available (1-7A)

Recommended Fuse Blocks With Box Connectors for Amp-Trap® Class J Fuses

Fuse Ampere Rating	Catalog Number 600V or Less	
	1 Pole	3 Pole
0-30	US3J1I	US3J3I
31-60	US6J1I	US6J3I
61-100	61036J	61038J
101-200	62001J	62003J
201-400	64031J	64033J
401-600	6631J	6633J

A variety of pole configurations and termination provisions are available, see section H.

Dimensions

Ampere Rating	A		B		C		D		E		F		G		H	
	in	mm	in	mm	in	mm	in	mm	in	mm	in	mm	in	mm	in	mm
1-30	2-1/4	57	13/16	21	-	-	-	-	-	-	-	-	-	-	-	-
31-60	2-3/8	60	1-1/16	27	-	-	-	-	-	-	-	-	-	-	-	-
61-100	4-5/8	117	1-1/16	27	1/8	3.2	3/4	19	1	25	3-5/8	92	3/8	10	9/32	7
101-200	5-3/4	146	1-5/8	41	3/16	4.8	1-1/8	29	1-3/8	35	4-3/8	111	3/8	10	9/32	7
201-400	7-1/8	181	2-1/8	54	1/4	6.3	1-5/8	41	1-7/8	48	5-1/4	133	17/32	14	13/32	10
401-600	8	203	2-1/2	64	3/8	9.5	2	51	2-1/8	54	6	152	11/16	18	17/32	13

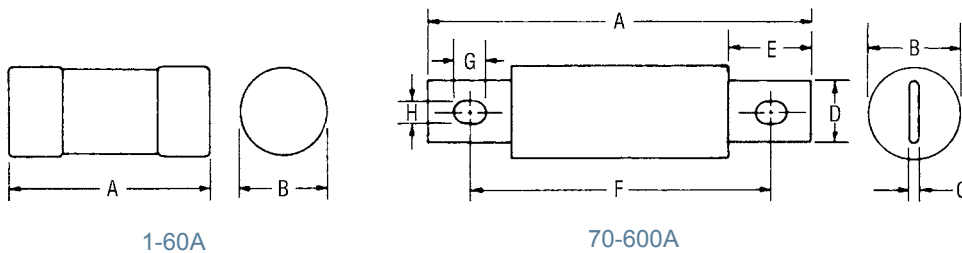

Optional Indicator/Microswitch Mount (EI) Dimensions:

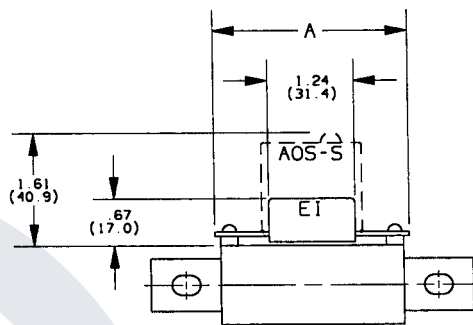

Note: Fuses with the EI option are designed to work with the AOS-S or AOS-Q add-on switch, which is ordered separately. See page J6 for details.

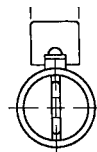

Catalog Number	A
AJT (70-100)-EI	2.8 (71.0)
AJT (110-200)-EI	3.22 (81.8)
AJT (225-400)-EI	3.24 (82.2)
AJT (450-600)-EI	3.61 (91.8)

AJT Reducer Fuses Time-delay/Class J

AJT Reducer Fuses are a safe permanent solution for decreasing your current rating without using a fuse reducer which are designed and list for temporary use only. These reducer fuses provide the same trusted protection levels as a traditional AJT fuses but in a larger body.

Features/Benefits:

- Replaces traditional temporary use only fuse reducers
- Recommended for Arc Flash energy reduction
- Extremely current-limiting for low peak let-thru current
- Most current-limiting UL class fuse
- Time-delay for motor starting and transformer inrush
- High-visibility orange label gives instant brand recognition
- Metal-embossed date and catalog number for traceability and lasting identification
- Fiberglass body provides dimensional stability in harsh industrial settings
- High-grade silica filler ensures fast arc quenching
- Optional EI indicator/switch

Highlights:

- Reducer Fuse
- Arc Flash mitigating
- Highly current-limiting
- Time-delay
- DC ratings
- Optional mechanical indicator

Applications:

- Motor circuits
- Mains
- Feeders
- Branch circuits
- Lighting, heating & general loads
- Transformers
- Control panels
- Circuit breaker back-up
- Bus duct
- Load centers

Note: See motor fuse applications tables on page P7



Ratings:

Volts : 600VAC or less
: 500VDC or less

Amps : 125 to 200A
(in 400A body)
: 250 to 400A
(in 600A body)

IR : 200kA I.R. AC
: 100kA I.R. DC

(Self-certified for 600VAC, 300kA I.R., UL witnessed).

Approvals:

AJT (1-600):

- UL listed to standard 248-8 File E2137
- IEC 269-2-1



AJT Reducer Fuses Time-delay/Class J

Catalog Numbers (amps)

Catalog Numbers	Amp Rating	Body Size
AJT125/400	125A	400A
AJT150/400	150A	
AJT175/400	175A	
AJT200/400	200A	
AJT250/600	250A	600A
AJT300/600	300A	
AJT350/600	350A	
AJT400/600	400A	

Recommended Fuse Blocks With Box Connectors for Amp-Trap® Class J Fuses

Fuse Ampere Rating	Catalog Number 600V or Less	
	1 Pole	3 Pole
125/400-200/400	64031J	64033J
250/600-400/600	6631J	6633J

A variety of pole configurations and termination provisions are available. See section H.

Dimensions

Ampere Rating	A		B		C		D		E		F		G		H	
	in	mm	in	mm	in	mm	in	mm	in	mm	in	mm	in	mm	in	mm
125/400-200/400	7-1/8	181	2-1/8	54	1/4	6.3	1-5/8	41	1-7/8	48	5-1/4	133	17/32	14	13/32	10
250/600-400/600	8	203	2-1/2	64	3/8	9.5	2	51	2-1/8	54	6	152	11/16	18	17/32	13

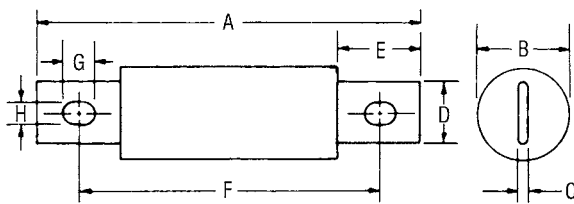

70-600A

Optional Indicator/Microswitch Mount (EI) Dimensions:

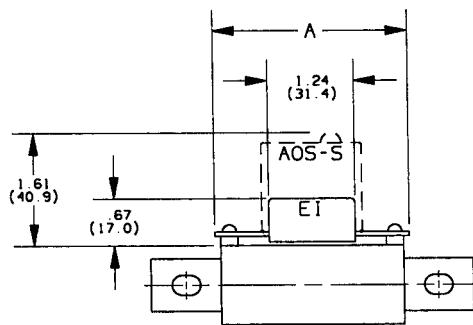

Note: Fuses with the EI option are designed to work with the AOS-S or AOS-Q add-on switch, which is ordered separately. See page J6 for details.

Catalog Number	A
AJT (125/400-200/400)-EI	3.24 (82.2)
AJT (250/600-400/600)-EI	3.61 (91.8)

A4BQ Time-delay/Class L

Put the highest current-limitation...at your service

Amp-Trap 2000® A4BQ fuses are 20% more current-limiting than any other Class L fuse on the market. When correctly coordinated, they bring a superior level of protection to service entrance equipment. Downstream circuit components have maximum protection against short circuit let-thru current. A4BQ's built-in, 4-second time-delay characteristic (at 500% of rated current) accommodates harmless inrush currents without nuisance opening.

Features/Benefits:

- Fastest operation under short circuit conditions: Let-thru currents are typically 20% lower, with a corresponding let-thru energy (clearing I^2t) up to 40% lower than the next fastest Class L fuse
- Time-delay for high inrush loads such as motors and transformers, without nuisance opening
- 300kA interrupting rating - self-certified, UL witnessed tests
- Most current-limiting for lowest peak let-thru current; even at fault currents up to 300kA
- Recommended for Arc Flash energy reduction
- Pure silver links ensure lowest let-thru current and longer fuse life
- Easy 2-to-1 selectivity for prevention of nuisance shutdowns and "blackouts"
- Rejection-style design prevents replacement errors
- High-visibility orange label gives instant brand recognition
- Reduced inventory because A4BQ can replace all older types of Class L fuses now in-service
- Metal-embossed date and catalog number for traceability and lasting identification
- Fiberglass body provides dimensional stability in harsh industrial settings
- High-grade silica filler ensures fast arc quenching

Highlights:

- Time-delay
- Industry's most current-limiting class L fuse
- Arc Flash mitigating
- Pure silver elements
- AC & DC rated
- Optional mechanical TA indicator (100-6000A)

Applications:

- Mains
- Feeders
- Large motors
- Lighting, heating & general loads
- Circuit breaker back-up
- DC rated: UPS DC links, battery disconnects, other DC applications

Please contact factory for special trigger actuator



Ratings:

Volts : 600VAC
: 500VDC

Amps : AC - 100 to 6000A
: DC - 100 to 3000A

IR : 200kA I.R. AC
: 100kA I.R. DC

(Self-certified for 600VAC, 300kA I.R., UL witnessed).

Approvals:

A4BQ (100-6000)

- UL listed to standard 248-10 File E2137
- DC listed to UL standard 248 (100-2000A)
- CSA certified to standard C22.2 No. 248.10 (601-6000A)

A4BQ (100-6000) - TA

- UL listed



A4BQ Time-delay/Class L

Catalog Numbers (amps)

A4BQ100	A4BQ500	A4BQ1000	A4BQ2000
A4BQ150	A4BQ600	A4BQ1200	A4BQ2500
A4BQ200	A4BQ601	A4BQ1350	A4BQ2501
A4BQ250	A4BQ650	A4BQ1400	A4BQ3000
A4BQ300	A4BQ700	A4BQ1500	A4BQ3500
A4BQ350	A4BQ750	A4BQ1600	A4BQ3800
A4BQ400	A4BQ800	A4BQ1800	A4BQ4000
A4BQ450	A4BQ900	A4BQ1900	A4BQ5000
			A4BQ6000

Note: For remote blown fuse trigger actuator option add "-TA" to end of catalog number. Example: A4BQ1600-TA

Recommended Fuse Blocks for Amp-Trap® Class L Fuses

Fuse Ampere Rating	Catalog Number 600V or Less 3 Pole
100-800	P48F
801-1200	P412F

Catalog number P48F is UL recognized
Catalog number P412F is self-certified

Dimensions

Ampere Rating	A		B		C		D		E	
	in	mm	in	mm	in	mm	in	mm	in	mm
100-600	8-5/8	219	2	51	5/16	8	1-5/8	41	2-13/32	61
601-800	8-5/8	219	2-1/2	63	3/8	9	2	51	2-13/32	61
801-1200	10-3/4	273	2-1/2	63	3/8	9	2	51	3-15/32	88
1201-1600	10-3/4	273	3	76	7/16	11	2-3/8	60	3-15/32	88
1601-2000	10-3/4	273	3-1/2	89	1/2	12	2-3/4	70	3-15/32	88
2001-2500	10-3/4	273	4-1/2	114	3/4	19	3-1/2	89	3-15/32	88
2501-3000	10-3/4	273	5	127	3/4	19	4	102	3-15/32	88
3001-4000	10-3/4	273	5-3/4	146	3/4	19	4-3/4	121	3-15/32	88
4001-5000	10-3/4	273	6-1/4	159	1	25	5-1/4	133	3-15/32	88
5001-6000	10-3/4	273	7-1/8	181	1	25	5-3/4	146	3-15/32	88

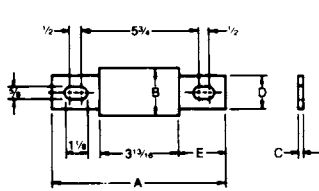

100-800A

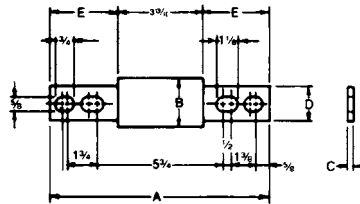

801-2000A

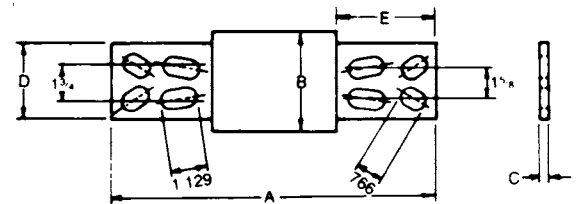

2001-3000A

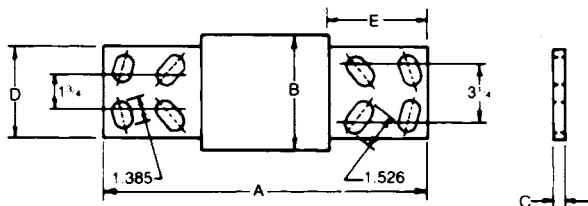

3001-4000A

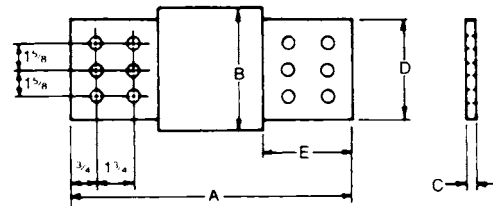

4001-6000A

Safety Note: Class L fuses are dimensioned for one-way interchangeability. A Class L fuse of any lower ampere rating can be substituted for a given Class L fuse.

A2D-R & A6D-R Time-delay/Class RK1

Upgrade yesterday's circuits to today's Type 2 protection

The Amp-Trap 2000® SmartSpot® A2D-R and A6D-R fuses feature a visual open fuse indicator and provide IEC Type 2 No Damage protection to main, feeder, and branch circuits for all types of loads. With time-delay characteristics for handling harmless in-rush currents, current-limiting ability and a wide range of ratings (from 1 to 600 Amperes), A2D-R and A6D-R fuses give excellent protection for all your applications.

Features/Benefits:

- Solid state SmartSpot visual blown fuse indicator
- Time-delay for motor starting and transformer inrush currents without nuisance opening
- 600VAC & 600VDC dual rated
- 300kA interrupting rating - self-certified, UL witnessed tests
- Extremely current-limiting for low peak let-thru current
- Recommended for Arc Flash energy reduction
- Easy 2-to-1 selectivity for prevention of nuisance shut downs and "black outs"
- Rejection-style design prevents replacement errors (when used with recommended fuse blocks)
- High-visibility orange label gives instant brand recognition
- Reduced inventory by taking the place of class RK5, K, and H fuses
- Metal-embossed date and catalog number for easier traceability and lasting identification
- Fiberglass body provides dimensional stability in harsh industrial settings

Highlights:

- SmartSpot indicator
- Time-delay
- Current-limiting
- Arc Flash mitigating
- Plated terminals

Applications:

- Motors
- Safety switches
- Transformers
- Branch circuit protection
- Disconnects
- Control panels
- All general-purpose circuits

Note: See motor fuse applications tables on page P7



Ratings:

A2D-R

- Volts** : 250VAC/DC
Amps : 1/10 to 600A (AC)
 : 15 to 600A (DC)
IR : 200kA I.R. AC
 : 100kA I.R. DC

A6D-R

- Volts** : 600VAC/DC
Amps : 1/10 to 600A
IR : 200kA I.R. AC
 : 100kA I.R. DC

(Self-certified for 300kA I.R., UL witnessed.)

Approvals:

- UL listed to standard 248-12 File E2137
- DC listed to UL standard 248
- CSA certified to standard C22.2 No. 248.12



A2D-R & A6D-R Time-delay/Class RK1

Catalog Numbers (amps)

250V			600V		
A2D1/10R	A2D3-1/2R	A2D50R	A6D1/10R	A6D3-1/2R	A6D50R
A2D15/100R	A2D4R	A2D60R	A6D15/100R	A6D4R	A6D60R
A2D2/10R	A2D4-1/2R	A2D70R	A6D2/10R	A6D4-1/2R	A6D70R
A2D3/10R	A2D5R	A2D75R	A6D3/10R	A6D5R	-
A2D4/10R	A2D5-6/10R	A2D80R	A6D4/10R	A6D5-6/10R	A6D80R
A2D1/2R	A2D6R	A2D90R	A6D1/2R	A6D6R	A6D90R
A2D6/10R	A2D6-1/4R	A2D100R	A6D6/10R	A6D6-1/4R	A6D100R
A2D8/10R	A2D7R	A2D110R	A6D8/10R	A6D7R	A6D110R
A2D1R	A2D8R	A2D125R	A6D1R	A6D8R	A6D125R
A2D1-1/8R	A2D9R	A2D150R	A6D1-1/8R	A6D9R	A6D150R
A2D1-1/4R	A2D10R	A2D175R	A6D1-1/4R	A6D10R	A6D175R
A2D1-4/10R	A2D12R	A2D200R	A6D1-4/10R	A6D12R	A6D200R
A2D1-6/10R	A2D15R	A2D225R	A6D1-6/10R	A6D15R	A6D225R
A2D1-8/10R	A2D17-1/2R	A2D250R	A6D1-8/10R	A6D17-1/2R	A6D250R
A2D2R	A2D20R	A2D300R	A6D2R	A6D20R	A6D300R
A2D2-1/4R	A2D25R	A2D350R	A6D2-1/4R	A6D25R	A6D350R
A2D2-1/2R	A2D30R	A2D400R	A6D2-1/2R	A6D30R	A6D400R
A2D2-8/10R	A2D35R	A2D450R	A6D2-8/10R	A6D35R	A6D450R
A2D3R	A2D40R	A2D500R	A6D3R	A6D40R	A6D500R
A2D3-2/10R	A2D45R	A2D600R	A6D3-2/10R	A6D45R	A6D600R

Note: SmartSpot visual indicator is not available (1/10-7A)

Recommended Fuse Blocks With Box Connectors for Amp-Trap® Class RK1 Fuses

Fuse Ampere Rating	Catalog Number			
	250V or Less		600V or Less	
	1 Pole	3 Pole	1 Pole	3 Pole
0-30	20306R	20308R	60306R	60308R
31-60	20606R	20608R	60606R	60608R
61-100	21036R	21038R	61036R	61038R
101-200	22001R	22003R	62001R	62003R
201-400	24001R	24003R	64001R	64003R
401-600	2631R	2633R	6631R	6633R

A variety of pole configurations and termination provisions is available, see section H.

Dimensions

Ampere Rating	A		B		C		D		E	
	In	mm	In	mm	In	mm	In	mm	In	mm
250V-A2D										
0-30	2	51	9/16	14	-	-	-	-	-	-
31-60	3	76	13/16	21	-	-	-	-	-	-
61-100	5-7/8	149	1-1/16	27	1/8	3	3/4	19	1	25
101-200	7-1/8	181	1-9/16	40	3/16	5	1-1/8	28	1-3/8	35
201-400	8-5/8	219	2-1/16	53	1/4	6	1-5/8	41	1-7/8	48
401-600	10-3/8	264	2-9/16	66	1/4	6	2	51	2-1/4	57
600V-A6D										
0-30	5	127	13/16	21	-	-	-	-	-	-
31-60	5-1/2	139	1-1/16	27	-	-	-	-	-	-
61-100	7-7/8	200	1-5/16	34	1/8	3	3/4	19	1	25
101-200	9-5/8	244	1-13/16	46	3/16	5	1-1/8	28	1-3/8	35
201-400	11-5/8	295	2-9/16	66	1/4	6	1-5/8	41	1-7/8	48
401-600	13-3/8	340	3-1/8	80	1/4	6	2	51	2-1/4	57



0-60A

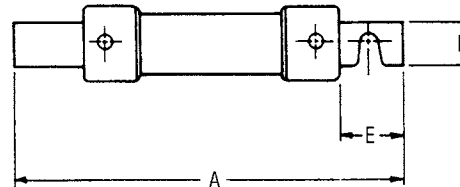
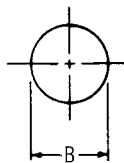

61-600A

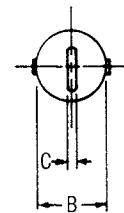

ATDR Time-delay/Class CC

The best protection for today's small motors

Amp-Trap 2000® ATDR small-dimension fuses can provide IEC Type 2 No Damage protection to your facility's increasingly sensitive branch circuit components and small motors – minimizing the risk of fault-related damage. ATDR Class CC fuses deliver the best time-delay characteristics in their class with excellent cycling ability for small motor loads.

Features/Benefits:

- Time-delay for motor starting inrush currents without nuisance opening
- Highly current-limiting for low peak let-thru current
- Improved cycling ability for frequent motor starts/stops without nuisance fuse opening
- Rejection-style design prevents replacement errors (when used with recommended fuse blocks)
- High-visibility orange label ensures instant brand recognition, simplifies replacement
- Metal-embossed date and catalog number for traceability and lasting identification
- Fiberglass body provides dimensional stability in harsh industrial settings
- High-grade silica filler ensures fast arc quenching and optimum current-limitation

Highlights:

- Time-delay
- Best choice for small motor protection
- Highly current-limiting
- AC & DC rated

Applications:

- Small motors
- Contactors
- Lighting, heating & general loads
- Branch circuit protection

Note: See motor fuse applications tables on page P7



Ratings:

- Volts** : 600VAC
 : 300VDC
- Amps** : 1/4 to 30A
- IR** : 200kA I.R. AC
 : 100kA I.R. DC

Approvals:

- UL listed to standard 248-4 File E2137
- CSA certified to standard C22.2 No. 248.4
- DC listed to UL standard 248



ATDR Time-delay/Class CC

Catalog Numbers (amps)

ATDR1/4	ATDR1-1/2	ATDR3	ATDR6	ATDR12
ATDR1/2	ATDR1-6/10	ATDR3-2/10	ATDR6-1/4	ATDR15
ATDR8/10	ATDR1-8/10	ATDR3-1/2	ATDR7	ATDR17-1/2
ATDR1	ATDR2	ATDR4	ATDR7-1/2	ATDR20
ATDR1-1/8	ATDR2-1/4	ATDR4-1/2	ATDR8	ATDR25
ATDR1-1/4	ATDR2-1/2	ATDR5	ATDR9	ATDR30
ATDR1-4/10	ATDR2-8/10	ATDR5-6/10	ATDR10	

Recommended Fuse Blocks for Class CC Fuses

Number of Poles	Catalog Numbers			
	UltraSafe™ Indicating Fuse Holder	Screw Connector w/ Double Quick Connects	Pressure Plate Connector w/ Double Quick Connects	Copper Box Connector
ADDER		30310R	30320R	30350R
1	USCC1I	30311R	30321R	30351R
2	USCC2I	30312R	30322R	30352R
3	USCC3I	30313R	30323R	30353R
3	USFMCCI			

Dimensions

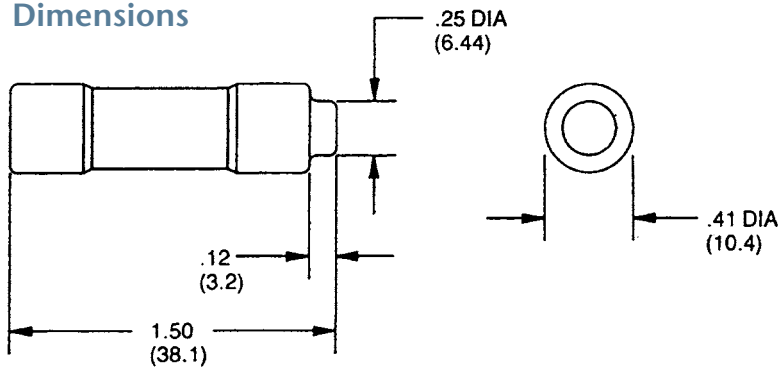

ATQR Time-delay/Class CC

Take control of fault currents headed for your control transformer

ATQR small-dimension fuses feature time-delay characteristics ideally suited for the high inrush currents of control transformers, solenoids, and similar inductive loads. Mersen's ATQR fuses provide superior protection for the branch circuits of electrical distribution systems.

Features/Benefits:

- Time-delay for control transformer inrush loads without nuisance opening
- Highly current-limiting for low peak let-thru current
- Rejection-style design prevents replacement errors (when used with recommended fuse blocks)
- High visibility orange label ensures instant brand recognition, and simplifies replacement
- Metal-embossed date and catalog number for traceability and lasting identification
- Fiberglass body provides dimensional stability in harsh industrial settings
- High-grade silica filler ensures fast arc quenching and high current limitation

Highlights:

- Time-delay
- Best choice for small transformer protection
- Current-limiting

Applications:

- Control transformers
- Solenoids
- Inductive loads
- Lighting, heating & general-purpose loads

Note: See motor fuse applications tables on page P7



Ratings:

- Volts** : 600VAC (1/10-30A)
: 300VDC (3-2/10 – 30A)
- Amps** : 1/10 to 30A
- IR** : 200kA I.R. AC
: 100kA I.R. DC

Approvals:

- UL listed to standard 248-4 File E2137
- DC listed to UL standard 248
- CSA certified to standard C22.2 No. 248.4



ATQR Time-delay/Class CC

Catalog Numbers (amps)

ATQR1/10	ATQR8/10	ATQR2-8/10	ATQR7-1/2
ATQR1/8	ATQR1	ATQR3	ATQR8
ATQR3/16	ATQR1-1/8	ATQR3-2/10	ATQR9
ATQR2/10	ATQR1-1/4	ATQR3-1/2	ATQR10
ATQR1/4	ATQR1-4/10	ATQR4	ATQR12
ATQR3/10	ATQR1-1/2	ATQR4-1/2	ATQR15
ATQR4/10	ATQR1-6/10	ATQR5	ATQR17-1/2
ATQR1/2	ATQR1-8/10	ATQR5-6/10	ATQR20
ATQR6/10	ATQR2	ATQR6	ATQR25
ATQR3/4	ATQR2-1/4	ATQR6-1/4	ATQR30
	ATQR2-1/2	ATQR7	

Recommended Fuse Blocks for Class CC Fuses

Number of Poles	Catalog Numbers			
	UltraSafe™ Indicating Fuse Holder	Screw Connector w/ Double Quick Connects	Pressure Plate Connector w/ Double Quick Connects	Copper Box Connector
ADDER		30310R	30320R	30350R
1	USCC1I	30311R	30321R	30351R
2	USCC2I	30312R	30322R	30352R
3	USCC3I	30313R	30323R	30353R
3	USFMCCI			

Dimensions

